

Nominal Size W x H x D (in)	Actual Size H x W x D (in)	Part Number	Capacity (CFM)	Resistance (in W.G.)	Media Area (sq ft)	Carton Qty	Weight per Carton (lbs)
24x24x4	23-3/8 x 23-3/8 x 3-3/4	120-700-001	2000	0.68	120	3	20
20x25x4	19-1/2 x 24-1/2 x 3-3/4	120-700-002	1750	0.68	111	3	18
20x24x4	19-1/2 x 23-3/8 x 3-3/4	120-700-003	1650	0.68	106	3	17
20x20x4	19-1/2 x 19-1/2 x 3-3/4	120-700-004	1100	0.68	88	3	13
18x24x4	17-1/2 x 23-3/8 x 3-3/4	120-700-005	1400	0.68	95	3	13
16x25x4	15-1/2 x 24-1/2 x 3-3/4	120-700-006	1400	0.68	88	3	13
16x20x4	15-1/2 x 19-1/2 x 3-3/4	120-700-007	1125	0.68	70	3	11
12x24x4	11-3/8 x 23-3/8 x 3-3/4	120-700-008	1750	0.68	63	6	20

Standard Construction:

1. Gradient Density Microfiberglass Media
2. Hotmelt Adhesive Media Separators
3. Moisture Resistant Beverage Board Frame (24 point)
4. Double Wall Frame

Specifications:

1. Efficiency: MERV 14 (ASHRAE Standard 52.2-2017)
2. Final Resistance: 1.5" W.G.
3. Rated Velocity: 500 FPM
4. Classified per UL Standard 900
5. Maximum Operating Temperature: 150 F (66 C)
6. Tolerance: Height & Width - +/- 1/8"
7. Tolerance: Depth - +/- 1/16"

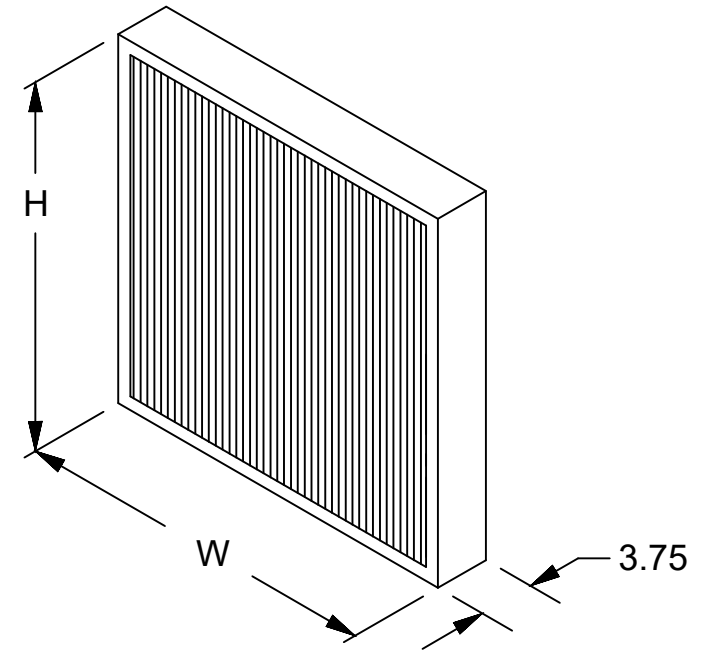

	MicroMAX Beverage Board MERV 14	REV	REVISION	BY / DATE
		LTR		
8401 Air Commerce Drive - Louisville KY 40219 Phone: (502) 634-4796 FAX: (502) 637-2280	Drawn By: Brent Chamberlain Date: May 22, 2023	Revision		